













W114 - W109 - W110 - W111
W112 - W113 - W210 - W160

-  Sollevatori idraulici da fossa
-  Hydraulic gear box and transmission jacks
-  Getriebeheber
-  Crics de fosse
-  Elevadores hidráulicos para fosa
-  **Dźwignik skrzyni biegów**



 **Nożna pompa, chromowana powierzchnia cylindra, zabezpieczenie przed samoczynnym opadaniem, obrotowe kółka**

-  Pompa a pedale • Stelo cromato • Comando proporzionale di discesa tipo 'uomo morto' • Ruote piroettanti
-  Pedal pump • Chromium plated piston rod • Proportional 'dead man' descent control • Castor wheels
-  Pedalpumpe • Verchromte Kolbenstange • Proportionales 'Totmann'-Senkregelventil • Drehbar gelagerte Räder
-  Pompe à pédale • Piston chromé • Baisse automatique proportionnelle type 'homme mort' • Roues pivotantes
-  Bomba de pedal • Vástago cromado • Mando proporcional de descenso tipo 'hombre muerto' • Ruedas pivotantes

Dati tecnici	Technical data	Technische Eigenschaften	Caractéristiques techniques	Datos técnicos	Dane techniczne			
MOD.	W114	W109	W210	W110	W111	W112	W113	W160
A	1120	1140	850	1140	1140	880	970	1250
B	1970	1990	1870	1990	1940	1900	1950	2100
C	700	900	900	950	1000	1000	880	900
L	450	550	580	550	600	600	550	630
M	450	600	580	650	700	700	550	630
N	25	30	30	35	45	35	45	60
Kg	27	29	49	37	62	58	95	135

	603	604	610	606	608	611	612	609
Udźwig Portata Capacity Tragfähigkeit Capacité Capacidad de carga (kg)	300	500	800	1000	1500	1500	4000	10000
Podwójna szybkość pompy Pompa a doppia velocità Double speed pump Pompe à double vitesse Zweistufige Pumpe Bomba de doble velocidad			X		X	X	X	X
Podwójny wysów tłoka Pistone a 2 sfili 2 stage piston 2-stufiger Kolben piston à 2 étages Pistón con 2 extracciones			X			X	X	
Adapter do precyzyjnego poziomowania Supporto sfilabile Extractable transmission adapter Abnehmbarer Montagekorb Corbeille débâtable Soporte extraíble	X	X	X	X	X	X	X	X

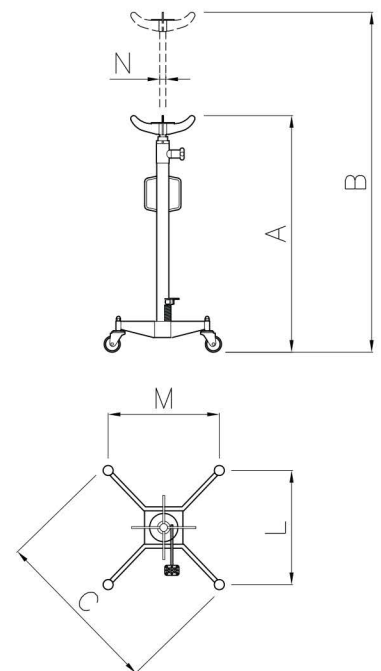

Opzioni

Optionals

Sonderzubehör

Options

Opcionales

Wyposażenie dodatkowe

606.1

603 - 604 - 606 - 610 - 611

Supporto orientabile con boccole di riduzione, capacità 500 kg

Orientable transmission support with reduction bushes, 500 kg capacity

Schwenkbare Getriebehalterung mit Reduktionsbuchsen, Tragkraft 500 kg

Support orientable pour boîtes de vitesse avec douilles de réduction, capacité 500 kg

Soporte orientable, con casquillos reductores, capacidad 500 kg

Adapter do precyzyjnego poziomowania skrzyni biegów z tuleją redukującą, udźwig 500 kg